

QUICK START GUIDE:

Use this Quick Start Guide to help you get set up and running immediately. Refer to our online help center at scale-tec.com for more information on operating your PROX™ Harvest Sensor.

PACKAGE CONTENTS

1 Quick Start Guide

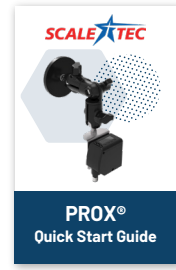

2 PROX™ Harvest Sensor

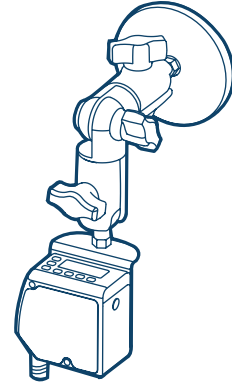

3 PROX Interface Cable

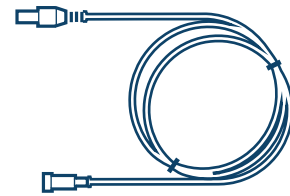

4 Status Light

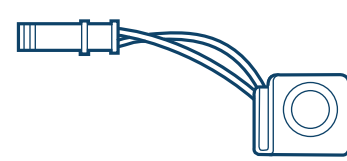

5 Status Light Cable

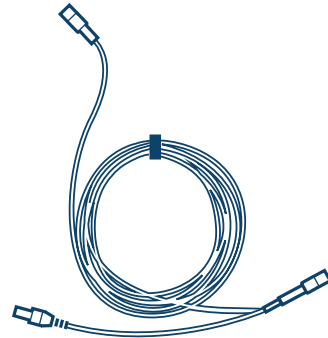

6 (2) 18ft Extension Cable

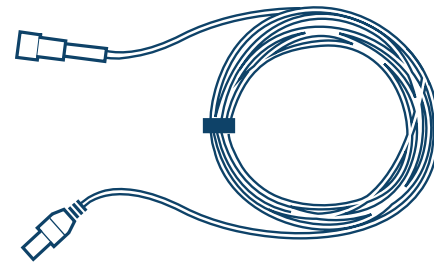

7 Y-Power Cable



PRODUCT SETUP

1 PROX INSTALLATION

1.1 Use the magnetic base to attach the PROX Harvest Sensor to the grain cart. For carts with side-folding augers, mount PROX on the front face of the cart. For carts with front-folding augers, mount PROX on the side of the grain cart.

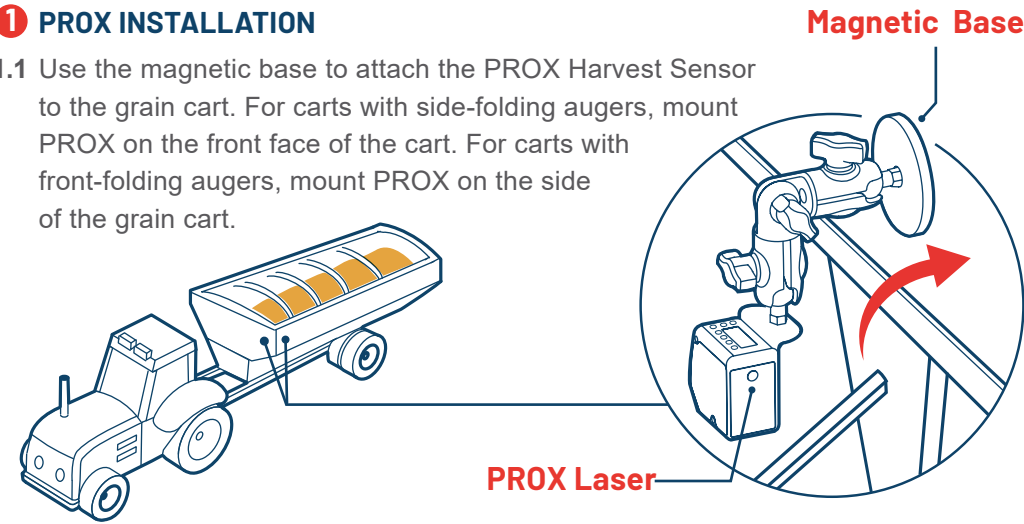

1.2 Adjust the mount to point the laser at the truck. Aim the laser about 18 inches below the top of the trailer, where the extended auger from the grain cart crosses over the top of the trailer. You will need to test the position and adjust if necessary after the installation.

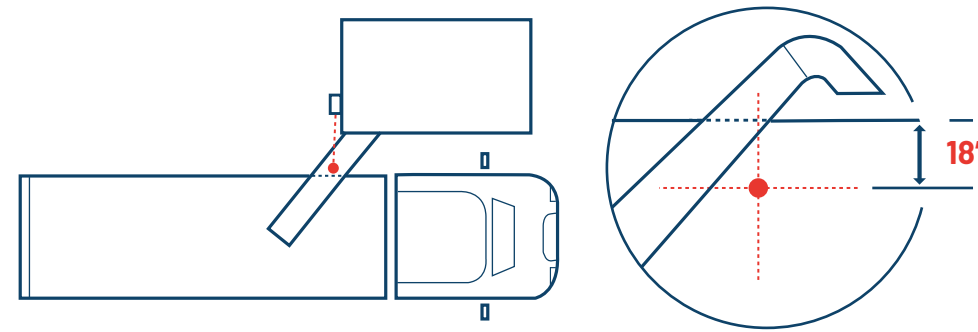

***NOTE**
Ensure the auger does not obstruct the field of view of the PROX Sensor during operation.

1.3 Route and connect the PROX Interface Cable to the quick disconnect on the PROX Sensor.

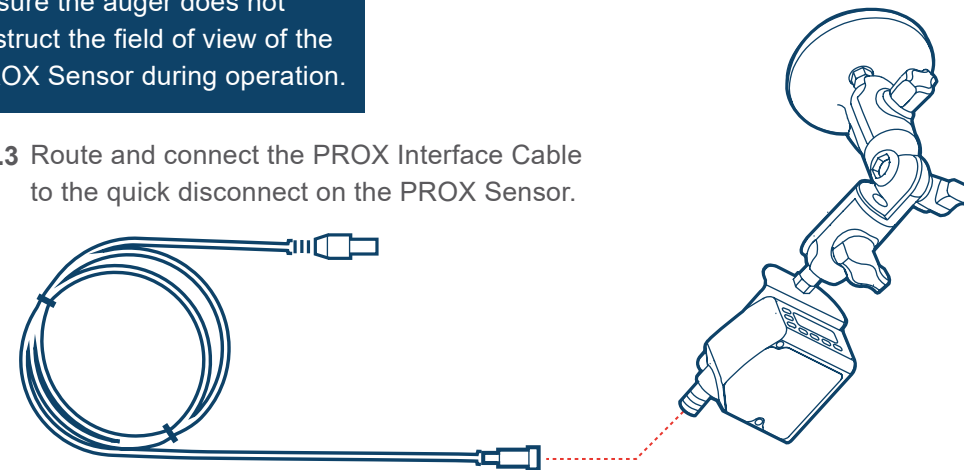

1.4 Connect the other end of the PROX Interface Cable to the four pin receptacle of the Status Light Cable.

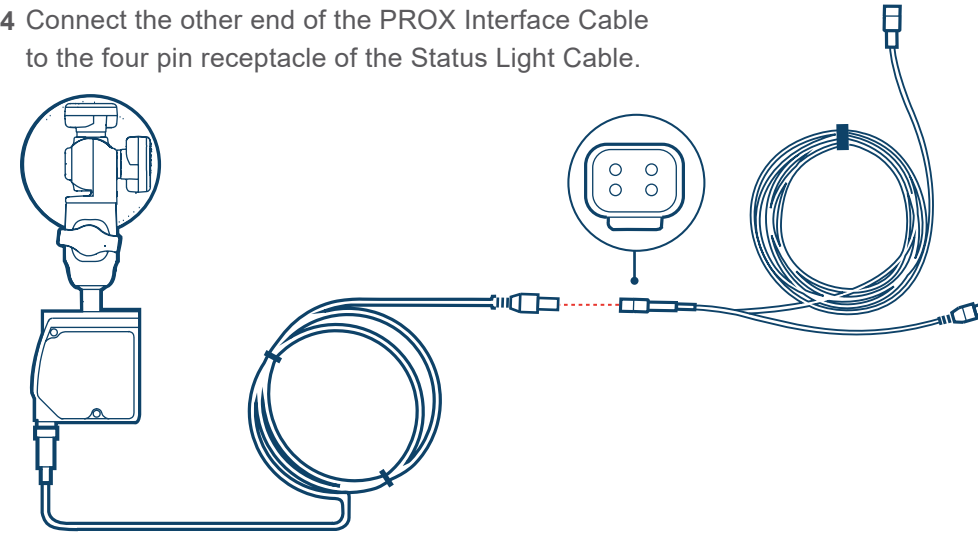

2 STATUS LIGHT INSTALLATION

2.1 Mount the Status Light in a visible area from the cab of the tractor.

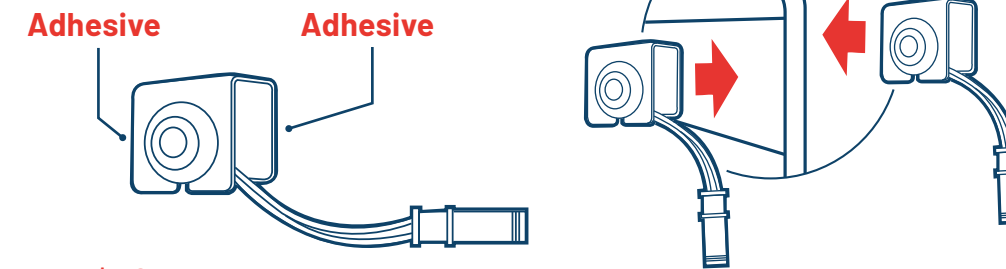

***NOTE**
The Status Light is used to show when the POINT® indicator is actively recording weight. When the Status Light is green, the POINT indicator is recording. When the status light is off, the POINT indicator is not recording. This can be used to provide a signal to the operator that it is okay to open their hydraulic gate.

2.2 Connect the Status Light Cable to the two pin connector at the bottom of the Status Light.

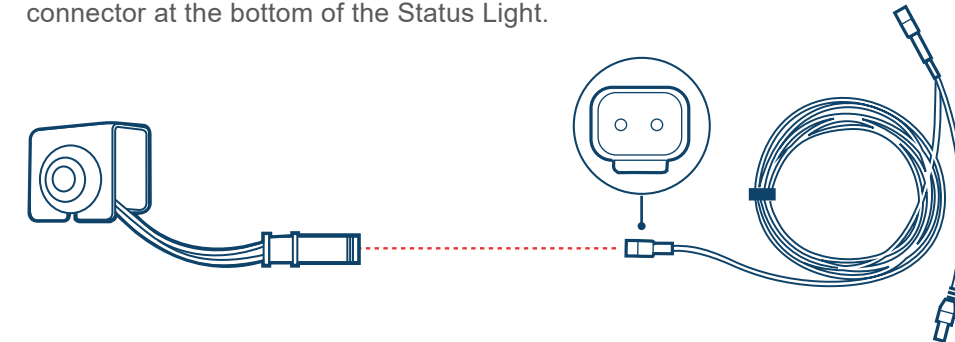

2.3 Connect the Status Light Cable to your POINT indicator. Use the 18ft Extension Cable(s) if needed.

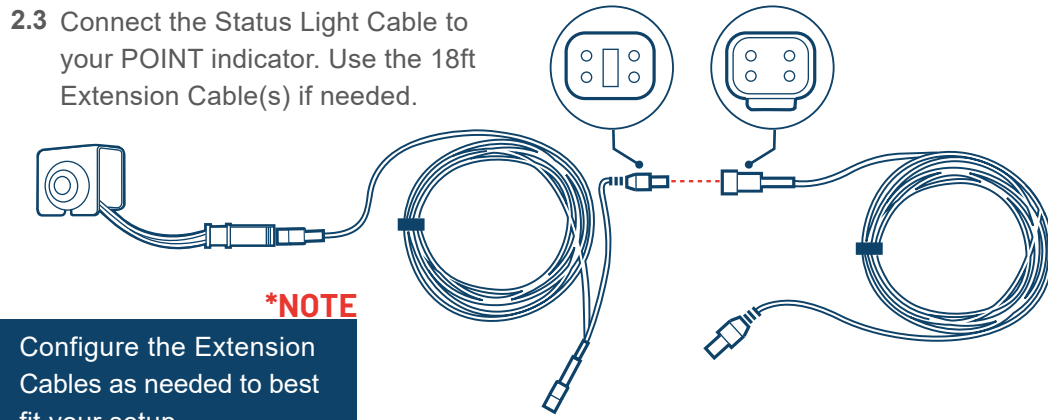

***NOTE**
Configure the Extension Cables as needed to best fit your setup.

3 PROX & STATUS LIGHT CABLE CONNECTION

3.1 Connect the 18ft Extension Cable to the Y-Power Cable adapter.

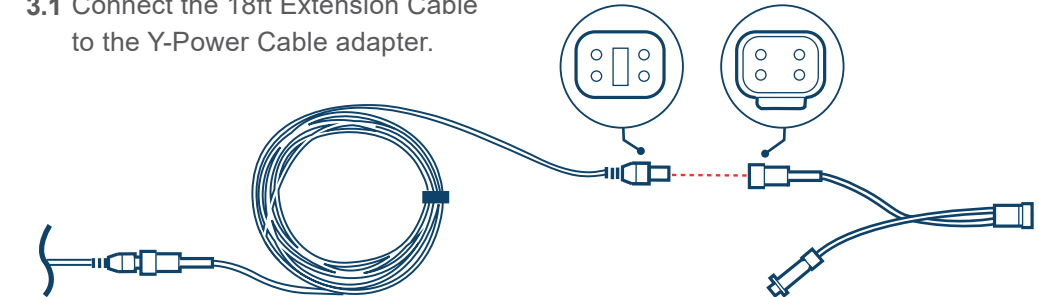

3.2 Connect your power cable into the other open receptacle of the Y-Power Cable adapter.

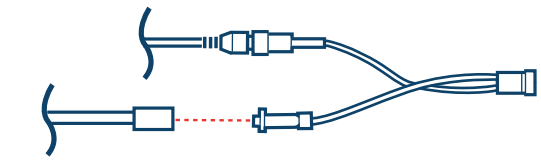

3.3 Route your power cable to a 12v DC power source.



***IMPORTANT**
If you are connecting your POINT indicator to an ISOBUS harness, do not use a power cable. 12v DC power will be supplied through the ISOBUS harness and connection.

***NOTE**
Scale-Tec recommends using keyed power when available.

BEFORE USING PROX IN THE FIELD

- Test the position of the laser and adjust if necessary (see step 1.2)
- Enable the PROX setting in your REAP app



www.scale-tec.com

16027 Hwy 64 East
Anamosa, IA 52205

1-888-962-2344
Patent Pending

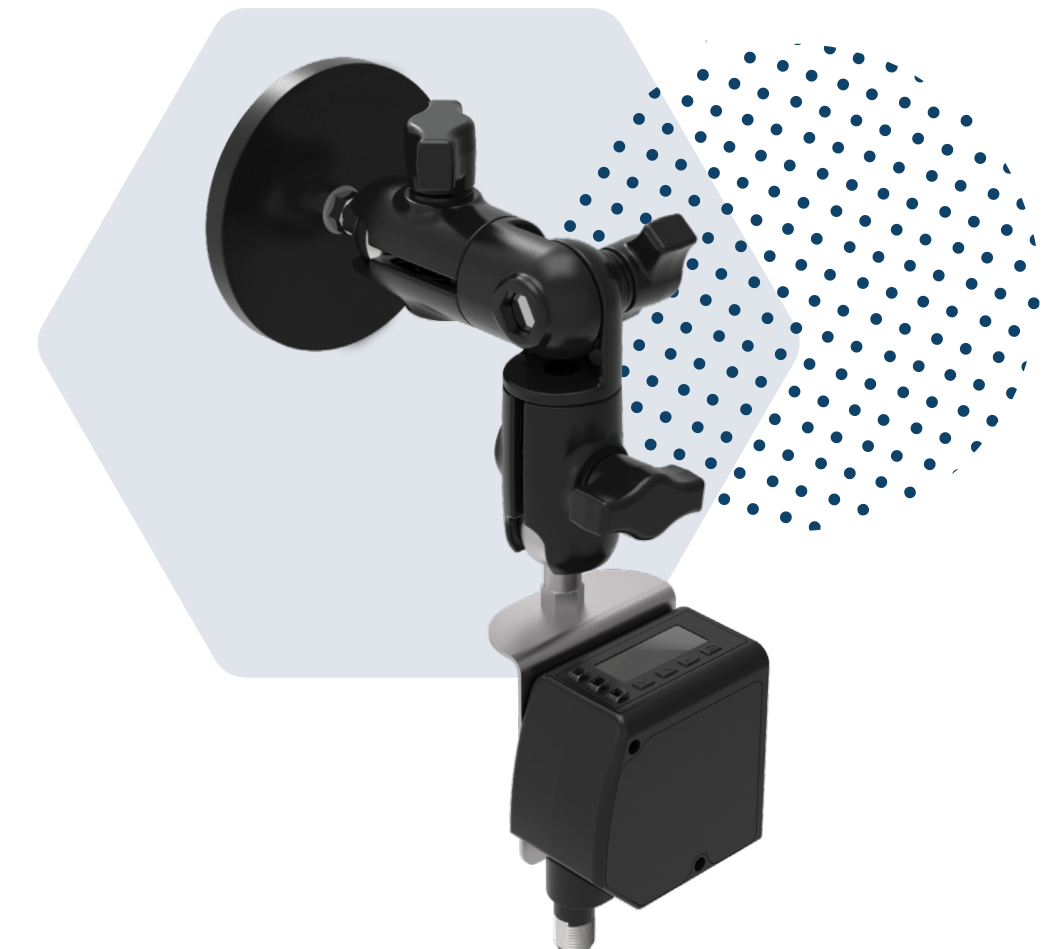

PROX™ Quick Start Guide